

Comptec

Comptec Door Drive (CDD) 5.0

Lift door controller

Steuerung von Aufzugstüren

Controller per porte di ascensore

QUICK REFERENCE

Note: the complete user manual can be downloaded from the website

www.compteelectronics.com

Bemerkung: Die vollständige Produktbeschreibung kann von unserer Website

www.compteelectronics.com heruntergeladen werden.

Nota: il manuale utente completo può essere scaricato dal sito internet

www.compteelectronics.com

English, page 2

(FW reference version:

02.00.xxx)

Deutsch, Seite 8

(Referenzfassung des Firmware:

02.00.xxx)

Italiano, pagina 14

(Versione FW di riferimento:

02.00.xxx)



EN
DE
IT



PRJ1166_03_07_03_QR

Rev.05

Reference Codes and Standards

All the references to the Standards and Codes are reported in the user manual.

Door Drive Data

Supply Voltage	[100 ; 240]Vac 1-ph 50-60Hz, (115V – 20%, 230V + 30%)	Vac
Available Peak Output Power	300	VA
Nominal Output Power	200	VA
Operating temperature	[-10; +60]	°C
Humidity	[20;80] non condensing	%
Electrical Protection	Fuse [5x20, 4A] fast on the main power supply line Fuse [5x20, 8A] on battery power line	-
Environmental Protection	IP-54 case	-

Compatible motors data

(Code) Motor Type	Nominal power	Nominal Voltage	Nominal current
(12) GR 63x25 + SG80K (15:1) + Enc100	50VA	24V	2.7A
(13) GR 63x55 + SG120 (15:1) +Enc100	100VA	24V	4.9A
(20) M63x50 + SN40 (15:1) + IGO100/2	100VA	24V	4.9A
(21) M63x25 + SN31 (15:1) + IGO100/2	100VA	24V	2.7A
(23) M48x60 + SN 22,6 (7:1) + IGO100/2	50VA	24V	1.5A
(01) Moog 1Nm (4:1 belt) + Enc500	100VA	24V	2.7A
(02) Moog 2Nm (4:1 belt) + Enc500	200VA	24V	1.5A

Installation

The installation of the drive has to be performed by expert technical personnel, having all the professional requirements expected, based on the active law in the installation country.

Before proceeding with the installation of the device, please verify the necessary safety equipment; check also the necessary instrument to execute all the installation operations. Be sure to work in safe conditions, taking the complete system in inspection mode before starting any activity.

The CDD 5.0 device works inside the complete car door operator, consisting of:

- Mechanical Door Operator: panels, carriages, belt, motor.
- Door drive (the CDD 5.0)
- Parallel interface to the main lift controller

Below it is represented the Device Connection Scheme:

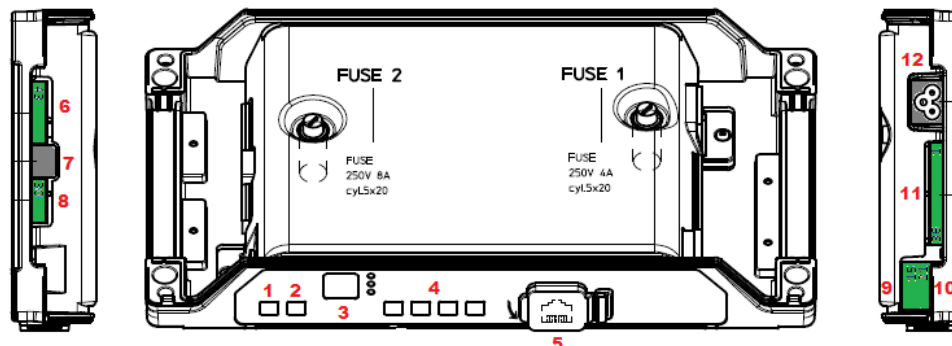

The door controller has:

N°	ID	Descrizione
1	ON	Power on button
2	OFF	Power off button
3	Display	7-segments (2 digits) for the visualization of the door drive status or programming
4	"1" "2" "3" "4"	Functional buttons for visualization/movement/programming
5	X8	external device connection for diagnostic, configuration and upgrade
6	X4	Motor and battery connector
7	X5	RJ45 Motor encoder connector
8	X9	Direct connection for light curtains, including 24Vdc power supply
9	X3.1	Connection of the commands from main lift controller
10	X3.2	Connection of the local contacts installed on the car
11	X2	Connection of the outputs to the main lift controller
12	X1	Connection of the main power supply

Please refer to the self-explicative cover sticker for the connection details.

Preliminary mechanical checks

Before proceeding with the installation of the drive, it is necessary to check the condition of the mechanical door operator: correct installation of the panels, correct installation of the carriages, correct installation of the transmission (belt and belt fixations), correct installation of the gear-motor according to the table reported on the previous page.

Verify that the panels movement results free, without obstacle or friction overall the complete door clearance.

Verify the material of the box: CDD 5.0 door drive, retrofit fixation bracket.

Mechanical installation

The mechanical installation of the door drive has to be executed according to the controller type to replace. For this reason the CDD 5.0 is supplied with the retrofit fixation bracket. The following table shows the two fixation possibilities:

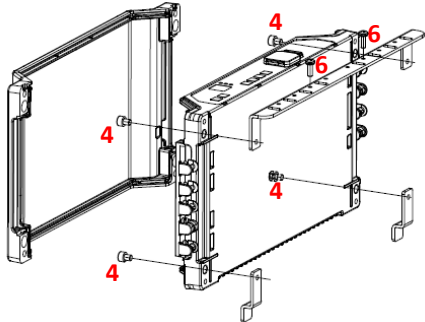
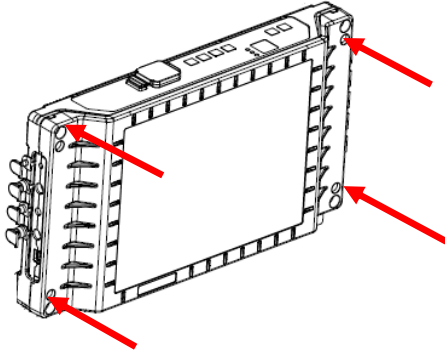
Installation with retrofit bracket	Direct installation
<ol style="list-style-type: none"> 1. Switch off the main power supply 2. Remove all the connection from the old controller 3. Remove the controller to be replaced 4. Remove the cover of the CDD 5.0. Apply the retrofit bracket to the CDD 5.0 5. Install the controller, using the fixation holes aligned to the holes present on the operator. 6. Apply the previous fixation screws 	<ol style="list-style-type: none"> 1. Switch off the main power supply 2. Remove all the connection from the old controller 3. Remove the controller to be replaced 4. Remove the cover of the CDD 5.0 5. Apply the drive using the four fixation points present on the operator.
	

Check of Electrical parts

Verify the presence of the correct supply voltage, as reported in the technical specifications.

Once the mechanical installation of the CDD 5.0 drive is completed , proceed as reported below.

STEP	Operation	Description																																																
0	Preliminary checks	Press OFF button on the door drive front panel. Be sure that no power supply is present.																																																
1	Motor connections 	Connect the motor cable to the pins: - 43: positive, BROWN - 44: negative, WHITE of the X4 connector. Keep in any case the previous connection order, in case no numbering rings are present, or in case the wires colour is different from the one described. Connect the encoder cable with its RJ45 male to the X5 connector. If present, connect the external battery kit to the positive (+) and negative (-) pins of the X4 connector.																																																
2	MLC interface connection 	In case of replacement of different controllers with different plugs proceed as following reported, otherwise plug the previous connectors as they are. Check the common voltage used, and the used contacts: <table border="1" style="width: 100%; margin-top: 10px;"> <thead> <tr> <th>Common</th> <th>Connections</th> </tr> </thead> <tbody> <tr> <td>Controller 24V</td> <td>Check the presence of the 37-38 bridge as GND reference</td> </tr> <tr> <td>External 24V (MLC)</td> <td>Remove the 37-38 bridge, only in case there are no local contact installed on the car roof</td> </tr> </tbody> </table> For further information please refer to the user manual Connection of the MLC commands and of the local contacts: <table border="1" style="width: 100%; margin-top: 10px;"> <thead> <tr> <th>PIN</th> <th>Name</th> <th>X3.1 Pin Description</th> </tr> </thead> <tbody> <tr> <td>15</td> <td>24V</td> <td>Auxiliary CDD 24V, available for MLC commands</td> </tr> <tr> <td>5</td> <td>DOC</td> <td>Opening command</td> </tr> <tr> <td>3</td> <td>DCC</td> <td>Closing command</td> </tr> <tr> <td>22</td> <td>RSC</td> <td>Reduced speed (closing) command</td> </tr> <tr> <td>23</td> <td>RVC</td> <td>Reversing command from detector</td> </tr> <tr> <td>39</td> <td>FFC</td> <td>Fire-Fighting mode enable input</td> </tr> </tbody> </table> <table border="1" style="width: 100%; margin-top: 10px;"> <thead> <tr> <th>PIN</th> <th>Name</th> <th>X3.2 Pin Description</th> </tr> </thead> <tbody> <tr> <td>42</td> <td>AUXC</td> <td>Programmable Auxiliary input</td> </tr> <tr> <td>41</td> <td>DTBC</td> <td>Second TB management input</td> </tr> <tr> <td>40</td> <td>EOC</td> <td>Battery Evacuation floor input</td> </tr> <tr> <td>38</td> <td>0V_IN</td> <td>GND input for the photo-coupled inputs</td> </tr> <tr> <td>37</td> <td>0V_DD</td> <td>Auxiliary GND of the drive for the inputs</td> </tr> <tr> <td>21</td> <td>BUZS</td> <td>Contact for Acoustic signal</td> </tr> </tbody> </table> For further information please refer to the user manual	Common	Connections	Controller 24V	Check the presence of the 37-38 bridge as GND reference	External 24V (MLC)	Remove the 37-38 bridge, only in case there are no local contact installed on the car roof	PIN	Name	X3.1 Pin Description	15	24V	Auxiliary CDD 24V, available for MLC commands	5	DOC	Opening command	3	DCC	Closing command	22	RSC	Reduced speed (closing) command	23	RVC	Reversing command from detector	39	FFC	Fire-Fighting mode enable input	PIN	Name	X3.2 Pin Description	42	AUXC	Programmable Auxiliary input	41	DTBC	Second TB management input	40	EOC	Battery Evacuation floor input	38	0V_IN	GND input for the photo-coupled inputs	37	0V_DD	Auxiliary GND of the drive for the inputs	21	BUZS	Contact for Acoustic signal
Common	Connections																																																	
Controller 24V	Check the presence of the 37-38 bridge as GND reference																																																	
External 24V (MLC)	Remove the 37-38 bridge, only in case there are no local contact installed on the car roof																																																	
PIN	Name	X3.1 Pin Description																																																
15	24V	Auxiliary CDD 24V, available for MLC commands																																																
5	DOC	Opening command																																																
3	DCC	Closing command																																																
22	RSC	Reduced speed (closing) command																																																
23	RVC	Reversing command from detector																																																
39	FFC	Fire-Fighting mode enable input																																																
PIN	Name	X3.2 Pin Description																																																
42	AUXC	Programmable Auxiliary input																																																
41	DTBC	Second TB management input																																																
40	EOC	Battery Evacuation floor input																																																
38	0V_IN	GND input for the photo-coupled inputs																																																
37	0V_DD	Auxiliary GND of the drive for the inputs																																																
21	BUZS	Contact for Acoustic signal																																																
3	Power supply connection 																																																	
4	Final checks	Verify that ALL the signals are connected and apply the cover . For further information please refer to the user manual																																																

HMI user interface

The CDD 5.0 door drive has a front panel that allows to activate different functional modes: Normal, Inspection, Configuration

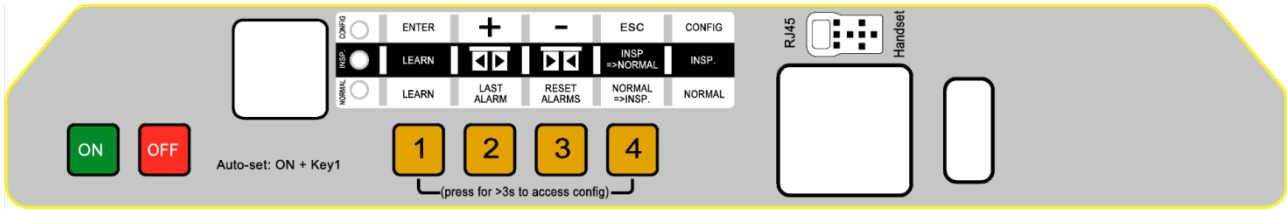



MODE		NORMAL	INSPECTION	CONFIGURATION
Description		Normal mode (automatic): the door drive executes the commands from MLC	Inspection mode (manual): the door drive executes commands from the panels keys	Configuration mode: parameters Programming
LEDS	NORMAL	ON	OFF	OFF
	INSP	OFF	ON	OFF
	CONFIG	OFF	OFF	ON
KEYS	1	Only Key 1 pressed for $t > 1s$: Self-learning activation Key 1 and key 4 pressed together per $t > 3s$: Configuration mode access	Only Key 1 pressed for $t > 1s$: Self-learning activation	Enter Access to parameter value OR Parameter value saving and return to parameters list
	2	Pressed and keep pressed ($t > 3s$): Last alarm code showed	Door opening	+ Increase Parameter index, OR Increase Parameter value
	3	Pressed for $t > 3s$: reset of the last alarm codes Key 2 and key 3 pressed together for $t > 3s$: Speed profiles reset	Door closing	- Decrease Parameter index, OR Decrease Parameter value
	4	Acces to Inspection mode (if only key 4 pressed for $t < 1s$) Access to Configuration mode (if Key 1 and key 4 pressed together for $t > 3s$)	Return to Normal mode	Esc Exit from parameter selection OR Exit from Configuration mode and return to Normal mode
DISPLAY		Door drive status showed: "--", "OP", "CL", "IM", "AL", ..	Door drive status showed: "--", "OP", "CL", "IM", "AL", ..	Parameter list: "P" alternate to the parameter index. Parameter modification: parameter value showed
NOTES		This is the default mode at the power on of the door drive. ALL inputs are active	ALL the signal from the MLC are not active	Paramer selection: "P" showed alternate to the parameter index

Door set-up, Learning and functional test

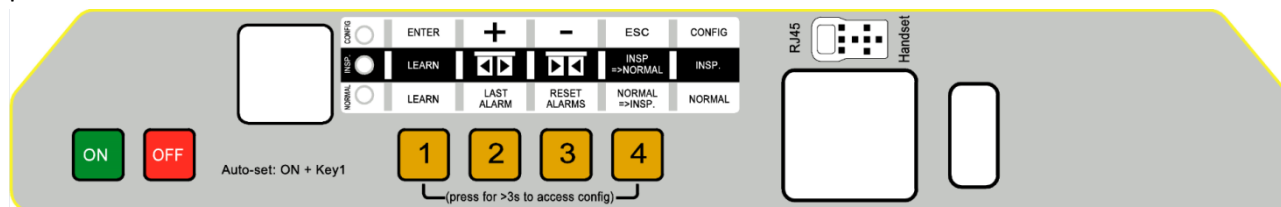
Once the installation phase described in the previous paragraph is completed, it is possible to proceed with the power on of the device and its configuration. In case of problems during the execution of the phases, please refer to the user manual.



STEP	Operation	Description	Visualisations										
1	Power supply test	Connect the main power supply. Press ON button on the door drive front panel	"88" followed by "- _ -"										
2	Door operator Configuration	Configure the parameters related to the installed mechanical door operator (please refer to chapter 5 of the user manual for details): <table border="1" style="width: 100%; border-collapse: collapse;"> <tr> <td>P05</td> <td>Car door locking device (0=not present, 1=present)</td> </tr> <tr> <td>P22</td> <td>Motor Closing rotation (0=clockwise, 1=counter-clockwise)</td> </tr> <tr> <td>P26</td> <td>Skate type (0=S20, 1=S90, 2=S120)</td> </tr> <tr> <td>P90</td> <td>Installed motor type (00=self-recognized)</td> </tr> <tr> <td>P99</td> <td>MLC commands logic (0=H active and RSC forced closing, 1=L active and RSC reduced speed, 2=H active and RSC reduced speed)</td> </tr> </table>	P05	Car door locking device (0=not present, 1=present)	P22	Motor Closing rotation (0=clockwise, 1=counter-clockwise)	P26	Skate type (0=S20, 1=S90, 2=S120)	P90	Installed motor type (00=self-recognized)	P99	MLC commands logic (0=H active and RSC forced closing, 1=L active and RSC reduced speed, 2=H active and RSC reduced speed)	-
P05	Car door locking device (0=not present, 1=present)												
P22	Motor Closing rotation (0=clockwise, 1=counter-clockwise)												
P26	Skate type (0=S20, 1=S90, 2=S120)												
P90	Installed motor type (00=self-recognized)												
P99	MLC commands logic (0=H active and RSC forced closing, 1=L active and RSC reduced speed, 2=H active and RSC reduced speed)												
3	Self-learning execution	Enter in the Door Drive Inspection mode, pressing key 4 and checking that INSP led is on. Press and keep pressed key 3 and check the door closing with reduced speed, if not closed. The door completes the panels and skate closing. Release key 3. In case the movement direction is wrong or in case of alarms, proceed with the checks suggested in the user manual. To optimize the execution of the learning procedure, it is suggested to couple car and landing door, executing the operations from the car roof in inspection mode. Press key 1 for at least 1s to enable Self-Learning. Press shortly key 2. The door starts opening with reduced speed until the door is completely opened. The learning phase is completed.	 INSP. Led ON "CL" blinking "CL" fixed "SL" fixed "SL" blinking "OP" fixed										
4	Speed Profiles check in Inspection mode	Press continuously key 3 to execute the door closing with normal speed, until the door is completely closed. Press continuously key 2 to execute the door opening with normal speed, until the door is completely opened. In case it is necessary to tune the speed profiles, please refer to the user manual.	"CL" blinking "CL" fixed "OP" blinking "OP" fixed										

<p>5</p>	<p>Obstacle reversing check in Inspection mode</p>	<p>Put an obstacle at different points of the door access.</p> <p>Press and keep pressed key 3, to perform a door closing. When the panels meet the obstacle, the door drive will immediately reverse the movement starting the reopening. Release key 3 during the reopening movement and wait until the door is completely opened.</p>	<p>“CL” blinking “IM” blinking “OP” fixed or “- -” blinking</p>
<p>6</p>	<p>Functional check in Normal mode</p>	<p>Complete the door closing, if not performed: press and keep pressed key 3 until the door is completely closed. Release key 3</p> <p>Activate the NORMAL mode of the controller, from the Inspection mode: press key 4 and check the led NORMAL is on.</p> <p>Now the controller works in Normal mode, and executes the commands received from the MLC, as well as the reversing from detector directly connected to the door controller.</p> <p>Perform all the functional check with the complete system operating in Normal mode, from the car roof or from the landing, according to the procedure active for the involved maintenance people.</p>	<p>“CL” blinking “CL” fixed</p>  <p>led NORMAL ON</p>

Installation Trouble-shooting

The installation sequence previously reported describes all the steps that have to be executed to operate a correct and complete set-up of the door system.

In case of issues, or anomalous behaviors happen during the installation, please refer to the user manual, part related to problems and solutions.

For any alarms, please refer to the user manual, part related to the Alarms.

Normierungs- und Gesetzesgrundlagen

Alle angewandten Normen und Gesetze werden im Handbuch genannt.

Daten der Türsteuerung

Versorgungsspannung	[100 ; 240] V CA einphasig 50-60Hz, (115V – 20%, 230V + 30%)	V CA
Mögliche Höchstspannung	300	CA
Nennleistung	200	CA
Betriebstemperatur	[-10; +60]	°C
Feuchtigkeit	[20;80] keine Kondensation	%
Elektrische Sicherheiten	Flinke Sicherung [5x20, 4A] auf der Hauptstromleitung Sicherung [5x20, 8A] auf der Batteriespeisung	-
Umweltschutz	Schutzbox mit IP54 Schutz	-

Daten der anwendbaren Motoren

(Code) Motortyp	Nennleistung	Nennspannung	Nennstrom
(12) GR 63x25 + SG80K (15:1) + Enc100	50VA	24V	2.7A
(13) GR 63x55 + SG120 (15:1) + Enc100	100VA	24V	4.9A
(20) M63x50 + SN40 (15:1) + IGO100/2	100VA	24V	4.9A
(21) M63x25 + SN31 (15:1) + IGO100/2	100VA	24V	2.7A
(23) M48x60 + SN 22,6 (7:1) + IGO100/2	50VA	24V	1.5A
(01) Moog 1Nm (4:1 Gurt) + Enc500	100VA	24V	2.7A
(02) Moog 2Nm (4:1 Gurt) + Enc500	200VA	24V	1.5A

Installation

Die Installation der Türsteuerung darf nur von erfahrenem Fachpersonal durchgeführt werden, das nach den gültigen gesetzlichen Bestimmungen des Installationslandes hierzu ermächtigt ist.

Vor der Installation müssen die erforderlichen Sicherheitsvorrichtungen überprüft werden. Darüber hinaus müssen die notwendigen Geräte für alle Installationsvorgänge vorhanden sein. Schließlich muß sichergestellt werden, daß die Anlage im Inspektionsmodus läuft, damit die Sicherheit der Monteure gewährleistet ist.

Das CDD 5.0 System, das in die Steuerung der Aufzugstüren eingesetzt wird, besteht aus folgenden Elementen:

- Mechanischer Türöffnungsmechanismus: Querträger, Laufwagen, Riemen, Motor
- Funktion (CDD 5.0)
- Kontaktschnittstelle mit der Aufzugssteuerung

Nachfolgend finden Sie das Anschluss-Schema des Gerätes:

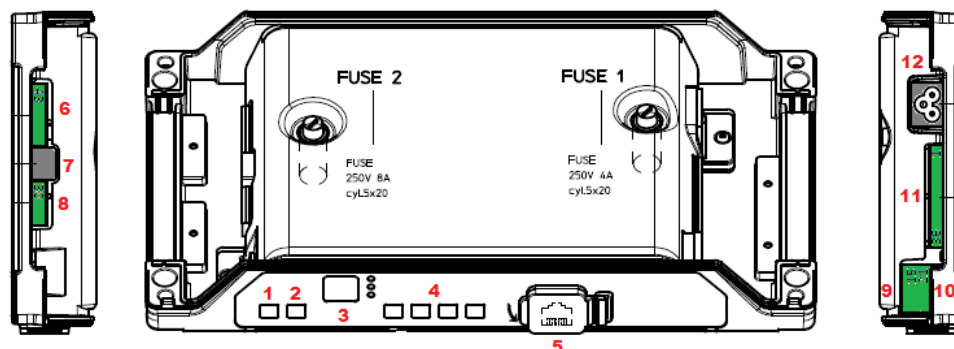

Die Türsteuerung besteht aus diesen Elementen:

N°	ID	Beschreibung
1	ON	Einschaltdruckknopf
2	OFF	Ausschaltdruckknopf
3	Display	7-Segment-Anzeige (2 Ziffern) um den Stand der Programmierung einzusehen
4	"1" "2" "3" "4"	Funktionstasten für Anzeige / Öffnungsmechanismus / Programmierung
5	X8	Verbindung mit den Anschlussvorrichtungen für das Upgrade und die Konfiguration
6	X4	Verbindung mit dem Motor und der Batterie
7	X5	RJ45 Encoder-Motor
8	X9	Direktanschluss der Lichtschranken mit Stromspeisung
9	X3.1	Befehlseingaben von der Steuerung
10	X3.2	Anschluss der Kontakteingänge auf dem Kabinendach
11	X2	Anschluss der Kontaktausgänge zur Steuerung
12	X1	Anschluss der Hauptstromspeisung

Sehen Sie die Details auf dem Siebdruck, der sich auf der Schutzabdeckung der Steuerung befindet.

Vorbereitende mechanische Überprüfungen

Bevor die Türsteuerung installiert wird, muss die korrekte Montage des Türöffnungsmechanismus überprüft werden. Das bedeutet: richtige Montage der Türflügel, richtige Montage der Laufwagen und des Übertragungsmechanismus (Befestigung der Riemen), richtige Montage des Antriebsmotors mit Untersetzung, wie in der Tabelle auf der vorhergehenden Seite beschrieben.

Überprüfen, daß die Türflügel frei laufen, ohne Hindernis auf der Öffnungslinie.

Den Inhalt der Steuerungsbox überprüfen: Steuerung CDD5.0, Befestigungsbügel, der für die Retrofit-Montage an der Steuerungsbox befestigt werden muß.

Mechanische Installation

Die mechanische Installation der Steuerung muß gemäß der Montage der vorherigen Steuerung durchgeführt werden. Daher wird die CDD5.0 Steuerung mit einem Retrofit-Bügel geliefert. Die nachfolgenden Zeichnung zeigt die Befestigungsmöglichkeiten.

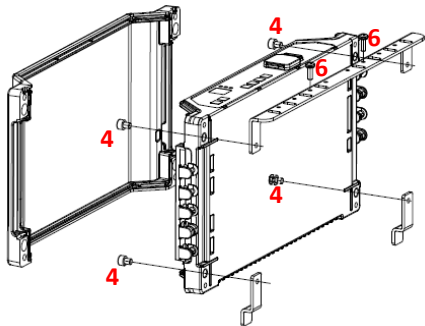
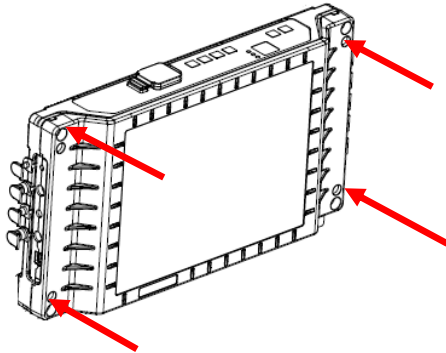
Befestigung mit Retrofit-Bügel	Direktmontage
<ol style="list-style-type: none"> 1. Die Hauptstromzufuhr unterbrechen 2. Alle Steuerungsanschlüsse, die ausgetauscht werden, abmontieren 3. Die vorherige Steuerung demontieren. 4. Den Befestigungsbügel CDD5.0 montieren 5. Die neue Steuerung so aufsetzen, daß die Befestigungsbohrungen der Steuerung mit der des Bügels übereinstimmen 6. Mit den alten Befestigungsschrauben festschrauben 	<ol style="list-style-type: none"> 1. Die Hauptstromzufuhr unterbrechen 2. Alle Steuerungsanschlüsse, die ausgetauscht werden, abmontieren 3. Die vorherige Steuerung demontieren. 4. Den Schutzdeckel der CDD5.0 Steuerung abnehmen 5. Die Steuerung an den vier Befestigungsbohrungen auf dem Türöffnungsmechanismus festschrauben
	

Überprüfung der elektrischen Teile

Überprüfen ob die richtige Versorgungsspannung, wie in der technischen Beschreibung angegeben, vorhanden ist. Wenn mechanische Bauteile und die CDD5.0 Steuerung installiert sind, mit der Montage wie folgt fortfahren:

N°	Arbeitsvorgang	Beschreibung																																																
0	Vorbereitende Überprüfungen	Auf dem vorderen Instrumentenbrett der Steuerung die Tast OFF/AUS drücken. Kontrollieren, daß die Stromspeisung unterbrochen ist.																																																
1	Anschluß des Motors 	Die Motordrähte an den Klemmen befestigen: - 43: positiv, BRAUN - 44: negativ, WEISS der Verbindung X4. In jedem Fall die vorhergehende Verbindungsordnung beibehalten, wenn keine Nummerierungsringe vorhanden sind, oder die Farben der Drähte nicht übereinstimmen. Das Kabel des Encoder-Wandlers RJ45 mit dem Stecker X5 verbinden. Wenn die Batteriespeisung vorgesehen ist, die Batterie an den positiven (+) und negativen (-) Klemmen der Verbindung X4 anschließen.																																																
2	Anschluß der Schnittstellen 	Die Art der gleichen Spannungen und der benutzen Kontakte überprüfen. <table border="1" style="width: 100%;"> <thead> <tr> <th>Gleichstrom</th> <th>Verbindungen</th> </tr> </thead> <tbody> <tr> <td>24V controller</td> <td>Brücke 37-38 für GND überprüfen</td> </tr> <tr> <td>24V extern (Steuerung)</td> <td>Brücke 37-38 nur dann entfernen, wenn keine Kontakte am Rand des Türmechanismus vorhanden sind</td> </tr> </tbody> </table> Weitere Informationen entnehmen Sie bitte dem Handbuch. Im Falle einer Erstinstallation oder einer Modernisierung von einem System mit verschiedenen Verbindungen, die Befehle von der Hauptsteuerung oder von bereits vorhandenen, angeschlossenen Geräten anschließen. <table border="1" style="width: 100%;"> <thead> <tr> <th>PIN</th> <th>Name</th> <th>Beschreibung PIN von X3.1</th> </tr> </thead> <tbody> <tr> <td>15</td> <td>24V</td> <td>Gleichspannung 24V für Befehle vorhanden</td> </tr> <tr> <td>5</td> <td>DOC</td> <td>Öffnungsbefehl</td> </tr> <tr> <td>3</td> <td>DCC</td> <td>Schließungsbefehl</td> </tr> <tr> <td>22</td> <td>RSC</td> <td>Erzwungene Schließung bei langsamer Geschwindigkeit</td> </tr> <tr> <td>23</td> <td>RVC</td> <td>Umkehrkontakt von der Lichtschanke</td> </tr> <tr> <td>39</td> <td>FFC</td> <td>Aktivierung Befehl Feuerwehr-Modus</td> </tr> <tr> <th>PIN</th> <th>Name</th> <th>Beschreibung PIN von X3.2</th> </tr> <tr> <td>42</td> <td>AUXC</td> <td>Programmierbarer Hilfskontakt</td> </tr> <tr> <td>41</td> <td>DTBC</td> <td>Kontakt für doppelte TB-Betätigung</td> </tr> <tr> <td>40</td> <td>EOC</td> <td>Kontakt für Evakuierung mit Batterie</td> </tr> <tr> <td>38</td> <td>OV_IN</td> <td>GND für Eingänge in Verbindung mit Lichtschanke</td> </tr> <tr> <td>37</td> <td>OV_DD</td> <td>GND für Eingänge des Antriebes</td> </tr> <tr> <td>21</td> <td>BUZS</td> <td>Kontakt für akustisches Warnsignal</td> </tr> </tbody> </table> Weitere Informationen entnehmen Sie bitte unserem Handbuch.	Gleichstrom	Verbindungen	24V controller	Brücke 37-38 für GND überprüfen	24V extern (Steuerung)	Brücke 37-38 nur dann entfernen, wenn keine Kontakte am Rand des Türmechanismus vorhanden sind	PIN	Name	Beschreibung PIN von X3.1	15	24V	Gleichspannung 24V für Befehle vorhanden	5	DOC	Öffnungsbefehl	3	DCC	Schließungsbefehl	22	RSC	Erzwungene Schließung bei langsamer Geschwindigkeit	23	RVC	Umkehrkontakt von der Lichtschanke	39	FFC	Aktivierung Befehl Feuerwehr-Modus	PIN	Name	Beschreibung PIN von X3.2	42	AUXC	Programmierbarer Hilfskontakt	41	DTBC	Kontakt für doppelte TB-Betätigung	40	EOC	Kontakt für Evakuierung mit Batterie	38	OV_IN	GND für Eingänge in Verbindung mit Lichtschanke	37	OV_DD	GND für Eingänge des Antriebes	21	BUZS	Kontakt für akustisches Warnsignal
Gleichstrom	Verbindungen																																																	
24V controller	Brücke 37-38 für GND überprüfen																																																	
24V extern (Steuerung)	Brücke 37-38 nur dann entfernen, wenn keine Kontakte am Rand des Türmechanismus vorhanden sind																																																	
PIN	Name	Beschreibung PIN von X3.1																																																
15	24V	Gleichspannung 24V für Befehle vorhanden																																																
5	DOC	Öffnungsbefehl																																																
3	DCC	Schließungsbefehl																																																
22	RSC	Erzwungene Schließung bei langsamer Geschwindigkeit																																																
23	RVC	Umkehrkontakt von der Lichtschanke																																																
39	FFC	Aktivierung Befehl Feuerwehr-Modus																																																
PIN	Name	Beschreibung PIN von X3.2																																																
42	AUXC	Programmierbarer Hilfskontakt																																																
41	DTBC	Kontakt für doppelte TB-Betätigung																																																
40	EOC	Kontakt für Evakuierung mit Batterie																																																
38	OV_IN	GND für Eingänge in Verbindung mit Lichtschanke																																																
37	OV_DD	GND für Eingänge des Antriebes																																																
21	BUZS	Kontakt für akustisches Warnsignal																																																
3	Stromspeisungsverbindung 																																																	
4	Abschließenden Überprüfungen	Kontrollieren, daß alle Signalmeldungen richtig angeschlossen worden sind und die Aluminiumabdeckung montieren . Um weitere Informationen zu erlangen, beziehen Sie sich auf das Handbuch.																																																

Schnittstelle HMI Benutzer

Auf dem vorderen Instrumentenbrett der CDD 5.0 Steuerung können verschiedene Funktionsmodalitäten eingegeben werden: Normal, Inspektion und Einstellungen.

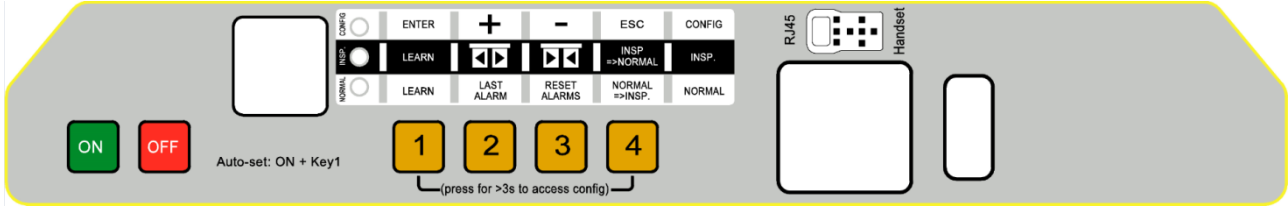

MODALITÄT		NORMAL	INSPEKTION	EINSTELLUNGEN
Beschreibung		Modalität normal (automatisch): Die Türsteuerung befolgt den Befehlen der Aufzugsteuerung	Inspektionsmodalität (manuell): Die Türsteuerung befolgt den Befehlen des Inspektions-tableaus	Einstellungsmodalität: Programmierung Parameter
LEDS	NORMAL	ON	OFF	OFF
	INSPEKTION	OFF	ON	OFF
	EINSTELLEN	OFF	OFF	ON
TASTEN	1	Nur die Taste t>1s drücken: Selbstlernprozeß aktivieren Gleichzeitiges Drücken mit Taste 4 für t>3s: Zugang zur Programmierung	Nur die Taste t>1s drücken: Selbstlernprozeß aktivieren	Taste Enter Parameterwert anzeigen Oder Parameterwert speichern und zurück zur Parameterliste
	2	Solange gedrückt halten (t>3s): Anzeige des Codes der letzten Warnmeldung	Öffnen der Tür	+ Zunahme Parameterindex, oder Zunahme Parameterwert
	3	Wenn t>3s gedrückt: Reset der letzten Warnmeldungen Gleichzeitiges Drücken mit Taste 3 für t>3s: Reset der Geschwindigkeitsprofile	Schließen der Tür	- Abnahme Parameterindex, Oder Abnahme Parameterwert
	4	Zugang zu Inspektionsmodalität (wenn nur Taste t<1s gedrückt) Zugang zur Programmierung (wenn 1+4 für t>3s gedrückt)	Rückkehr zur Normalfunktion	Taste Esc Ausgang aus der Parameterwahl Oder Ausgang aus der Programmierungswahl und Rückkehr in Normalfunktion
DISPLAY		Zeigt den Zustand der Steuerung an: "- -", "OP", "CL", "IM", "AL", ..	Zeigt den Zustand der Steuerung an: "- -", "OP", "CL", "IM", "AL", ..	Bei Parameterdurchlauf wird "P" alternativ zum Parameterindex angezeigt. Bei Parameteränderung wird der Parameterwert angezeigt.
BEMERKUNG		Das ist die Ausgangsmodalität beim Einschalten der Steuerung. ALLE Eingänge sind aktiviert.	Alle Signale von der Aufzugsteuerung sind deaktiviert.	Parameterwahl: "P" alternativ in der Parameterliste angezeigt

Lernprozeß und Funktionstest

DE

Wenn die Installation, wie im vorhergehenden Kapitel beschrieben, abgeschlossen ist, geht man zur Inbetriebnahme und zur Programmierung der Anlage über. Bei Problemen während der Durchführung dieser Arbeitsgänge, bitte das Handbuch konsultieren.

DE

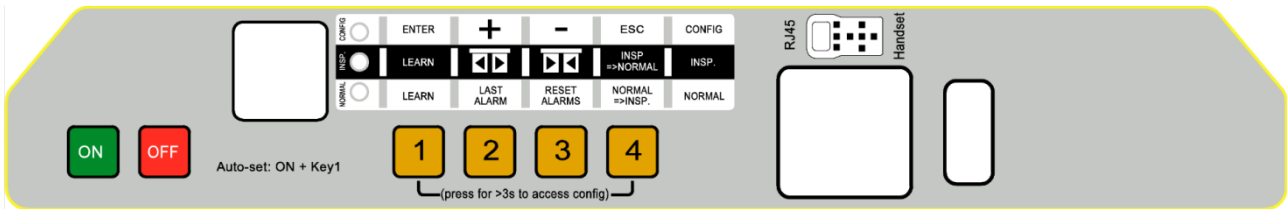

Abschnitt	Arbeitsvorgang	Beschreibung	Anzeigen										
1	Test Stromspeisung	Die Hauptstromspeisung anschließen. Die Taste ON auf dem Instrumentenbrett der Steuerung drücken	"88" gefolgt von "- -"										
2	Programmierung des Türöffnungsmechanismus	Die Identifikationsparameter des installieren Türöffnungsmechanismus eingeben (für Details, Kapitel 5 des Handbuches einsehen): <table border="1" style="width: 100%; border-collapse: collapse;"> <tr> <td style="width: 10%;">P05</td> <td>Kabinentürverriegelung (0=nicht vorhanden, 1=vorhanden)</td> </tr> <tr> <td>P22</td> <td>Drehrichtung beim Schließen (0=im Uhrzeigersinn, 1=entgegen dem Uhrzeigersinn)</td> </tr> <tr> <td>P26</td> <td>Art des Schwertes (0=S20, 1=S90, 2=S120)</td> </tr> <tr> <td>P90</td> <td>Art des installierten Motors (00=selbsterkennen)</td> </tr> <tr> <td>P99</td> <td>Befehlslogik QM (0=Aktiv H und RSC erzwungen Schließung, 1= Aktiv L und RSC langsame Geschwindigkeit, 2=Aktiv H und RSC langsame Geschwindigkeit)</td> </tr> </table>	P05	Kabinentürverriegelung (0=nicht vorhanden, 1=vorhanden)	P22	Drehrichtung beim Schließen (0=im Uhrzeigersinn, 1=entgegen dem Uhrzeigersinn)	P26	Art des Schwertes (0=S20, 1=S90, 2=S120)	P90	Art des installierten Motors (00=selbsterkennen)	P99	Befehlslogik QM (0=Aktiv H und RSC erzwungen Schließung, 1= Aktiv L und RSC langsame Geschwindigkeit, 2=Aktiv H und RSC langsame Geschwindigkeit)	-
P05	Kabinentürverriegelung (0=nicht vorhanden, 1=vorhanden)												
P22	Drehrichtung beim Schließen (0=im Uhrzeigersinn, 1=entgegen dem Uhrzeigersinn)												
P26	Art des Schwertes (0=S20, 1=S90, 2=S120)												
P90	Art des installierten Motors (00=selbsterkennen)												
P99	Befehlslogik QM (0=Aktiv H und RSC erzwungen Schließung, 1= Aktiv L und RSC langsame Geschwindigkeit, 2=Aktiv H und RSC langsame Geschwindigkeit)												
3	Durchführung Lernprozeß	Die Bewegungsinspektionsmodalität aktivieren, durch Drücken der Taste 4 und Überprüfung ob die LED INSP aufleuchten. Taste 3 drücken und gedrückt halten, und kontrollieren, ob die Tür in langsamer Geschwindigkeit schließt. Die Tür beendet das Schließen der Türflügel und des Schwertes. Taste 3 loslassen. Bei Umkehrung der Drehrichtung oder der Alarmsignale, die im Handbuch erklärten Kontrollen durchführen. Zur bestmöglichen Durchführung der Lernprozesse wird empfohlen, die Kabinen- und die Etagentür gemeinsam vom Kabinendach zu testen. Die Taste 1 mindestens 1s drücken, um den Selbstlernprozeß auszulösen. Kurz die Taste 2 drücken. Die Tür öffnet in langsamer Geschwindigkeit bis zur kompletten Öffnung der Tür. Der Lernprozeß ist abgeschlossen.	 LED INSP leuchtet "CL" blinkt "CL" leuchtet permanent "SL" leuchtet permanent "SL" blinkt "OP" leuchtet permanent										

<p>4</p>	<p>Überprüfung der Bewegungen in der Inspektionsmodalität</p>	<p>Die Taste 3 drücken und gedrückt halten, um die Türschließung bis zur vollständigen Schließung durchzuführen. Die Taste 2 drücken und gedrückt halten, um die Türöffnung bis zur vollständigen Öffnung durchzuführen.</p> <p>Wenn erforderlich die Geschwindigkeitsprofile ändern, unter Zuhilfenahme des Handbuchs.</p>	<p>“CL” blinkt “CL” permanent “OP” blinkt “OP” permanent</p>
<p>5</p>	<p>Kontrolle der Umkehrungen bei Schließung in der Inspektionsmodalität</p>	<p>Ein Hindernis in verschiedenen Punkten des Kabinenzuganges aufstellen.</p> <p>Taste 3 drücken und gedrückt halten, um die Tür zu schließen. Wenn die Türflügel auf das Hindernis stoßen, findet eine komplette Bewegungsumkehr statt. Taste 3 während der Wiederöffnung loslassen.</p>	<p>“CL” blinkt “IM” blinkt “OP” permanent oder “- -“ blinkend</p>
<p>6</p>	<p>Kontrolle der Arbeitsweise in Normalfunktion</p>	<p>Die Türschließung komplett durchführen; wenn nicht durchgeführt: Taste 3 drücken und gedrückt halten, bis die Tür komplett geschlossen ist. Taste 3 loslassen.</p> <p>Die normale Bewegungsfunktion aktivieren. Von der Inspektionsmodalität, durch Drücken der Taste 4, wobei das LED NORMAL aufleuchtet.</p> <p>Jetzt arbeitet die Türsteuerung in Normalfunktion und führt alle Befehle durch, die sie von der Aufzugsteuerung erhält, sowie die Umkehrbefehle von den Lichtschranken, die direkt mit der Türsteuerung verbunden sind.</p> <p>Die Überprüfung der Funktionen soll beim Aufzug in Normalfunktion erfolgen. Diese Überprüfung kann vom Kabinendach oder von der Etage aus erfolgen, je nach den Anweisungen an das Kundendienstpersonal.</p>	<p>“CL” blinkt “CL” permanent</p>  <p>LED NORMAL leuchtet</p>

Lösung von Installationsproblemen

Der Installationsablauf beschreibt alle Abschnitte, die für eine ordnungsgemäße und vollständige Installation und Inbetriebnahme der Anlage beachtet werden müssen.

Sollten sich während der Installation Abweichungen oder Probleme ergeben, soll auf das Handbuch, im Abschnitt Probleme und mögliche Lösungen, Bezug genommen werden.

Für alle Warnsignale soll auf das Handbuch, im Abschnitt Warnsignale, Bezug genommen werden.

Normative di riferimento

Si rimandano tutti i riferimenti normativi al manuale utente.

Dati Door Drive

Tensione di alimentazione	[100 ; 240]Vac monofase 50-60Hz, (115V – 20%, 230V + 30%)	Vac
Potenza disponibile di picco	300	VA
Potenza nominale	200	VA
Temperatura di esercizio	[-10; +60]	°C
Umidità	[20;80] non condensante	%
Protezioni elettriche	Fusibile [5x20, 4A] rapido su linea alimentazione principale Fusibile [5x20, 8A] su linea alimentazione batteria	-
Protezioni ambientali	Contenitore con protezione IP-54	-

Dati motori compatibili

(Codice) Tipo motore	Potenza nominale	Tensione nominale	Corrente nominale
(12) GR 63x25 + SG80K (15:1) + Enc100	50VA	24V	2.7A
(13) GR 63x55 + SG120 (15:1) +Enc100	100VA	24V	4.9A
(20) M63x50 + SN40 (15:1) + IGO100/2	100VA	24V	4.9A
(21) M63x25 + SN31 (15:1) + IGO100/2	100VA	24V	2.7A
(23) M48x60 + SN 22,6 (7:1) + IGO100/2	50VA	24V	1.5A
(01) Moog 1Nm (4:1 cinghia) + Enc500	100VA	24V	2.7A
(02) Moog 2Nm (4:1 cinghia) + Enc500	200VA	24V	1.5A

Installazione

L'installazione dell'automazione deve essere eseguita esclusivamente da personale tecnico competente e in possesso dei requisiti professionali previsti dalla legislazione vigente nel paese di installazione.

Prima di procedere all'installazione, verificare i dispositivi di sicurezza necessari; verificare inoltre la strumentazione necessaria per eseguire tutte le operazioni. Assicurarsi di lavorare in piena sicurezza, portando il sistema completo in modalità di ispezione.

Il sistema CDD 5.0 si inserisce all'interno del sistema operatore di porte per ascensore, composto da:

- Operatore meccanico di porta: Traversa, Carrelli, Cinghia, Motore
- Azionamento (appunto CDD 5.0)
- Interfaccia a contatti verso il quadro generale di manovra

Di seguito è riportato lo schema di connessione del dispositivo:

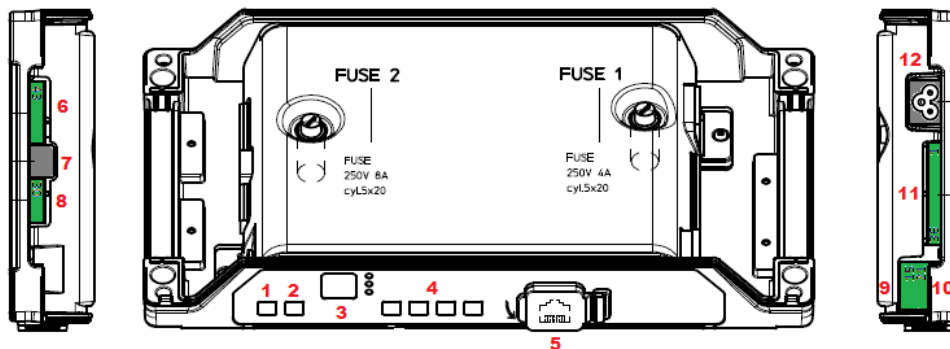

Il controller è dotato di:

N°	ID	Descrizione
1	ON	Pulsante di accensione
2	OFF	Pulsante di spegnimento
3	Display	Display 7-segmenti (due cifre) per visualizzazione stato/programmazione
4	"1" "2" "3" "4"	Tasti funzionali per visualizzazione/movimentazione/programmazione
5	X8	Connessione dispositivo esterno di aggiornamento/configurazione
6	X4	Connettore motore/batteria
7	X5	RJ45 encoder motore
8	X9	Connessione diretta barriere ottiche completo di alimentazione
9	X3.1	Connessione comandi del quadro di manovra
10	X3.2	Connessione ingressi contatti presenti sul tetto di cabina
11	X2	Connessione uscite verso il quadro di manovra
12	X1	Connessione alimentazione principale

Fare riferimento alla serigrafia auto-esplicativa riportata sulla cover del controller per i dettagli.

Verifiche preliminari meccaniche

Prima di procedere all'installazione dell'automazione è necessario verificare il corretto stato di installazione dell'operatore: corretta installazione dei pannelli, corretta installazione dei carrelli, corretta installazione del sistema di trasmissione (attacchi cinghia, cinghia), corretta installazione del motoriduttore in accordo alla tabella riportata alla pagina precedente.

Verificare che il movimento dei pannelli sia libero, senza ostacoli lungo tutta la corsa.

Verificare il contenuto del box: Controller CDD5.0, Staffa di fissaggio da ancorare al controller, per il montaggio retrofit

Installazione meccanica

L'installazione meccanica del controller deve essere eseguita tenendo conto del tipo di controller installato precedentemente. Per questo motivo il controller CDD5.0 è fornito con una staffa di retrofit. La seguente tabella mostra le possibilità di fissaggio.

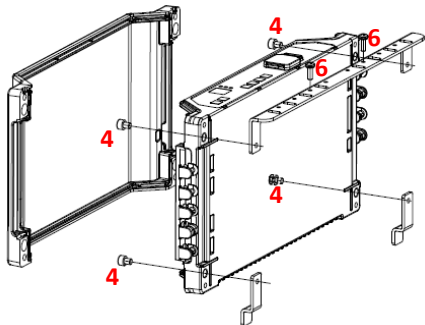
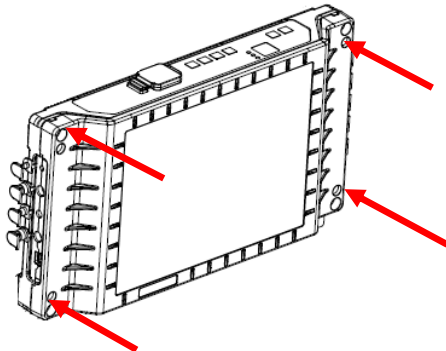
Fissaggio con staffa di retrofit	Fissaggio diretto
<ol style="list-style-type: none"> 7. Spegner l'alimentazione principale 8. Rimuovere tutte le connessioni del controller da sostituire 9. Rimuovere il controller da sostituire 10. Applicare la staffa di fissaggio al CDD5.0 11. Alloggiare il controller, facendo corrispondere i fori di fissaggio ai fori passanti presenti sulla staffa 12. Applicare le viti di fissaggio precedenti 	<ol style="list-style-type: none"> 6. Spegner l'alimentazione principale 7. Rimuovere tutte le connessioni del controller da sostituire 8. Rimuovere il controller da sostituire 9. Rimuovere il coperchio del CDD5.0 10. Fissare il controller ai quattro punti di fissaggio presenti sull'operatore
	

Verifica delle parti elettriche

Verificare la presenza della corretta tensione di alimentazione, come riportato nelle specifiche tecniche.

Una volta terminati i montaggi meccanici, e fissato il controller CDD5.0, procedere come indicato di seguito.

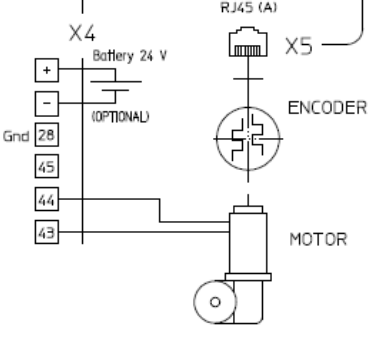
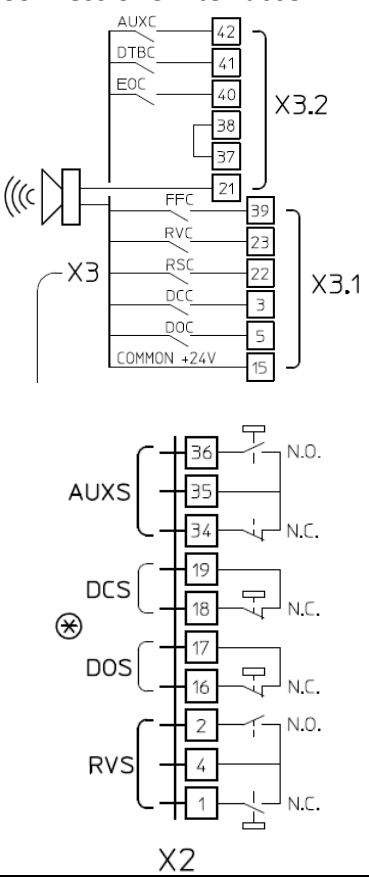
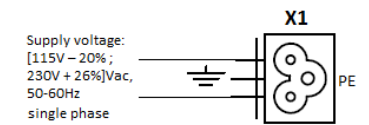
Passo	Operazione	Descrizione																																																
0	Verifiche preliminari	Premere il tasto OFF sul pannello frontale del controller. Accertarsi che non sia presente tensione di alimentazione.																																																
1	Connessione del motore 	Collegare i fili del motore ai morsetti: <ul style="list-style-type: none"> - 43: positivo, MARRONE - 44: negativo, BIANCO del connettore X4. Mantenere in ogni caso l'ordine di connessione precedente, nel caso non siano presenti anelli di numerazione, oppure nel caso in cui la colorazione dei fili non corrisponda. Collegare il cavo del trasduttore encoder con RJ45 al connettore X5 Collegare, se presente, il modulo batteria esterno ai morsetti positivo (+) e negativo (-) del connettore X4.																																																
2	Connessione interfacce 	Verificare la tipologia di tensione comune e dei contatti utilizzati: <table border="1" data-bbox="670 929 1444 1097"> <thead> <tr> <th>Comune</th> <th>Connessioni</th> </tr> </thead> <tbody> <tr> <td>24V controller</td> <td>Verificare presenza ponticello 37-38 per riferimento di GND</td> </tr> <tr> <td>24V esterno (QM)</td> <td>Togliere il ponticello 37-38 solo nel caso non siano presenti contatti a bordo operatore</td> </tr> </tbody> </table> Per ulteriori informazioni fare riferimento al manuale utente. Collegare (nel caso di prima installazione o di sostituzione di sistemi con diversi connettori) i comandi provenienti dal Quadro di Manovra o da dispositivi collegati (se presenti). <table border="1" data-bbox="670 1254 1444 1769"> <thead> <tr> <th>PIN</th> <th>Nome</th> <th>Descrizione pin di X3.1</th> </tr> </thead> <tbody> <tr> <td>15</td> <td>24V</td> <td>Tensione 24V comune disponibile per i comandi</td> </tr> <tr> <td>5</td> <td>DOC</td> <td>Comando di apertura</td> </tr> <tr> <td>3</td> <td>DCC</td> <td>Comando di chiusura</td> </tr> <tr> <td>22</td> <td>RSC</td> <td>Comando di chiusura forzata bassa velocità</td> </tr> <tr> <td>23</td> <td>RVC</td> <td>Contatto di inversione da barriera</td> </tr> <tr> <td>39</td> <td>FFC</td> <td>Comando per attivazione modalità Fire-Fighting</td> </tr> </tbody> </table> <table border="1" data-bbox="670 1500 1444 1769"> <thead> <tr> <th>PIN</th> <th>Nome</th> <th>Descrizione pin di X3.2</th> </tr> </thead> <tbody> <tr> <td>42</td> <td>AUXC</td> <td>Contatto ausiliario programmabile</td> </tr> <tr> <td>41</td> <td>DTBC</td> <td>Contatto per gestione doppio TB</td> </tr> <tr> <td>40</td> <td>EOC</td> <td>Contatto per gestione piano evacuazione in batteria</td> </tr> <tr> <td>38</td> <td>0V_IN</td> <td>GND per gli ingressi foto-accoppiati</td> </tr> <tr> <td>37</td> <td>0V_DD</td> <td>GND del drive disponibile per ingressi</td> </tr> <tr> <td>21</td> <td>BUZS</td> <td>Contatto per avvisatore acustico</td> </tr> </tbody> </table> Per ulteriori informazioni fare riferimento al manuale utente.	Comune	Connessioni	24V controller	Verificare presenza ponticello 37-38 per riferimento di GND	24V esterno (QM)	Togliere il ponticello 37-38 solo nel caso non siano presenti contatti a bordo operatore	PIN	Nome	Descrizione pin di X3.1	15	24V	Tensione 24V comune disponibile per i comandi	5	DOC	Comando di apertura	3	DCC	Comando di chiusura	22	RSC	Comando di chiusura forzata bassa velocità	23	RVC	Contatto di inversione da barriera	39	FFC	Comando per attivazione modalità Fire-Fighting	PIN	Nome	Descrizione pin di X3.2	42	AUXC	Contatto ausiliario programmabile	41	DTBC	Contatto per gestione doppio TB	40	EOC	Contatto per gestione piano evacuazione in batteria	38	0V_IN	GND per gli ingressi foto-accoppiati	37	0V_DD	GND del drive disponibile per ingressi	21	BUZS	Contatto per avvisatore acustico
Comune	Connessioni																																																	
24V controller	Verificare presenza ponticello 37-38 per riferimento di GND																																																	
24V esterno (QM)	Togliere il ponticello 37-38 solo nel caso non siano presenti contatti a bordo operatore																																																	
PIN	Nome	Descrizione pin di X3.1																																																
15	24V	Tensione 24V comune disponibile per i comandi																																																
5	DOC	Comando di apertura																																																
3	DCC	Comando di chiusura																																																
22	RSC	Comando di chiusura forzata bassa velocità																																																
23	RVC	Contatto di inversione da barriera																																																
39	FFC	Comando per attivazione modalità Fire-Fighting																																																
PIN	Nome	Descrizione pin di X3.2																																																
42	AUXC	Contatto ausiliario programmabile																																																
41	DTBC	Contatto per gestione doppio TB																																																
40	EOC	Contatto per gestione piano evacuazione in batteria																																																
38	0V_IN	GND per gli ingressi foto-accoppiati																																																
37	0V_DD	GND del drive disponibile per ingressi																																																
21	BUZS	Contatto per avvisatore acustico																																																
3	Connessione alimentazione 																																																	
4	Verifiche finali	Verificare che tutti i segnali siano stati collegati e chiudere il coperchio in alluminio. Per ulteriori informazioni fare riferimento al manuale utente.																																																

Interfaccia utente HMI

Il controller CDD 5.0 dispone di un pannello frontale che permette di attivare diverse modalità di funzionamento: Normale, Ispezione e Configurazione.

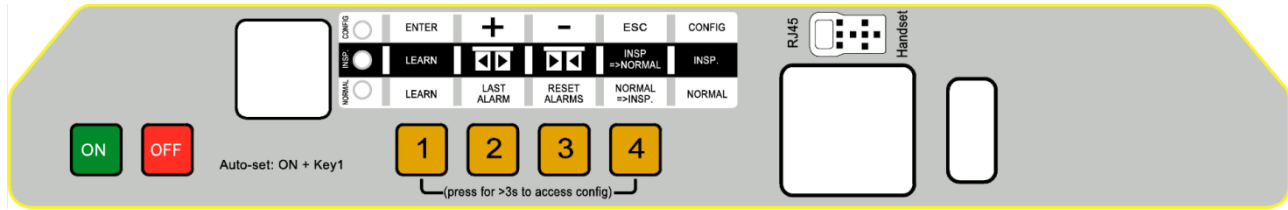



MODALITA'		NORMALE	ISPEZIONE	CONFIGURAZIONE
Descrizione		Modalità normale (automatica): Il controller obbedisce ai comandi del Q.M.	Modalità ispezione (manuale): Il controller esegue i comandi dai tasti del pannello	Modalità Configurazione: Programmazione parametri
LEDS	NORMAL	ON	OFF	OFF
	INSP	OFF	ON	OFF
	CONFIG	OFF	OFF	ON
TASTI	1	Pressione del solo tasto per t>1s: Attivazione Self-learning Pressione contemporanea con tasto 4 per t>3s: Ingresso in Programmazione	Pressione del solo tasto per t>1s: Attivazione Self-learning	Enter Visualizzazione valore parametro Oppure Salvataggio valore parametro e ritorno alla lista parametri
	2	Finché mantenuto premuto (t>3s): Visualizza codice ultimo allarme	Apertura porta	+ Incremento indice parametro, Oppure Incremento valore parametro
	3	Se premuto per t>3s: reset ultimi allarmi Pressione contemporanea con tasto 3 per t>3s: Reset dei profili di velocità	Chiusura porta	- Decremento indice parametro, Oppure Decremento valore parametro
	4	Ingresso in modalità Ispezione (se premuto da solo per t<1s) Ingresso in Configurazione (se premuti 1+4 for t>3s)	Ritorno alla modalità Normale	Esc Uscita dalla selezione del parametro Oppure Uscita dalla modalità Configurazione e ritorno in modalità Normale
DISPLAY		Visualizza lo stato del controller: "- -", "OP", "CL", "IM", "AL", ..	Visualizza lo stato del controller: "- -", "OP", "CL", "IM", "AL", ..	In scorrimento lista parametri visualizza "P" alternato all'indice del parametro. In modifica valore visualizza il valore del parametro
NOTE		Questa è la modalità di default all'accensione del controller. TUTTI gli ingressi sono attivi	Tutti i segnali provenienti dal Q.M. sono disattivati	Selezione del parametro: visualizzato "P" alternato all'indice del parametro

Apprendimento e Test di funzionamento

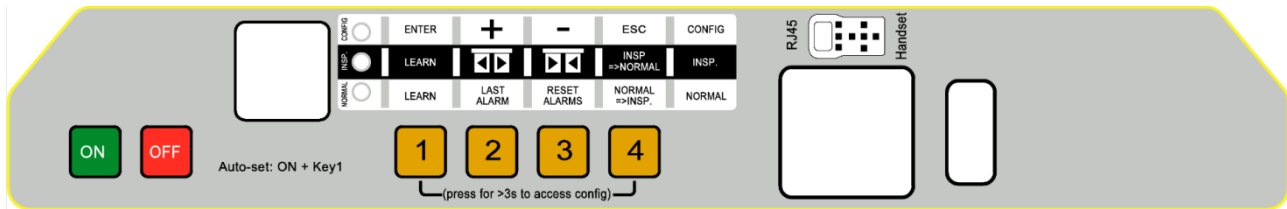
Una volta completata l'installazione descritta al paragrafo precedente, si procede all'accensione e alla configurazione del sistema. In caso di problemi durante l'esecuzione delle varie fasi, fare riferimento al manuale.



Passo	Operazione	Descrizione	Visualizzazioni										
1	Test alimentazione	Collegare l'alimentazione principale. Premere il tasto ON sul pannello frontale del controller	"88" seguito da "- -"										
2	Configurazione operatore	Configurare i parametri identificativi dell'operatore installato (riferirsi al capitolo 5 del manuale utente per i dettagli): <table border="1" data-bbox="507 869 1177 1137"> <tr> <td>P05</td> <td>Gancio di cabina (0=non presente, 1=presente)</td> </tr> <tr> <td>P22</td> <td>Senso di rotazione del motore in chiusura (0=orario, 1=antiorario)</td> </tr> <tr> <td>P26</td> <td>tipo di scivolo (0=S20, 1=S90, 2=S120)</td> </tr> <tr> <td>P90</td> <td>Tipo di motore installato (00=auto-riconoscimento)</td> </tr> <tr> <td>P99</td> <td>Logica comandi QM (0=Attivi H e RSC chiusura forzata, 1= Attivi L e RSC velocità ridotta, 2=Attivi H e RSC velocità ridotta)</td> </tr> </table>	P05	Gancio di cabina (0=non presente, 1=presente)	P22	Senso di rotazione del motore in chiusura (0=orario, 1=antiorario)	P26	tipo di scivolo (0=S20, 1=S90, 2=S120)	P90	Tipo di motore installato (00=auto-riconoscimento)	P99	Logica comandi QM (0=Attivi H e RSC chiusura forzata, 1= Attivi L e RSC velocità ridotta, 2=Attivi H e RSC velocità ridotta)	-
P05	Gancio di cabina (0=non presente, 1=presente)												
P22	Senso di rotazione del motore in chiusura (0=orario, 1=antiorario)												
P26	tipo di scivolo (0=S20, 1=S90, 2=S120)												
P90	Tipo di motore installato (00=auto-riconoscimento)												
P99	Logica comandi QM (0=Attivi H e RSC chiusura forzata, 1= Attivi L e RSC velocità ridotta, 2=Attivi H e RSC velocità ridotta)												
3	Esecuzione apprendimento	Attivare la modalità Ispezione di movimentazione, premendo il tasto 4 e verificare l'accensione del led INSP . Premere e mantenere premuto il tasto 3 e verificare che la porta chiuda in bassa velocità. La porta completa la chiusura dei pannelli e dello scivolo. Rilasciare il tasto 3. In caso di inversione del senso di rotazione o di allarmi, eseguire le verifiche suggerite nel manuale utente. Per una esecuzione ottimale delle procedure di apprendimento, si consiglia di accoppiare la porta di cabina a quella di piano, eseguendo le operazioni in ispezione dal tetto di cabina. Premere il tasto 1 per almeno 1s, per attivare il Self-learning. Premere brevemente il tasto 2. La porta inizia ad aprire in bassa velocità fino alla completa apertura della porta. La fase di apprendimento è completata.	 led INSP. acceso "CL" lampeggiante "CL" fisso "SL" fisso "SL" lampeggiante "OP" fisso										
4	Verifica movimenti in modalità Ispezione	Premere e mantenere premuto il tasto 3 per eseguire la chiusura della porta, fino alla completa chiusura. Premere e mantenere premuto il tasto 2 per eseguire l'apertura della porta, fino alla completa apertura. Nel caso fosse necessario regolare i profili di velocità, fare riferimento al manuale utente.	"CL" lampeggiante "CL" fisso "OP" lampeggiante "OP" fisso										

<p style="text-align: center; font-size: 2em; font-weight: bold;">5</p>	<p>Verifica delle inversioni in chiusura in modalità Ispezione</p>	<p>Posizionare un ostacolo in punti diversi dell'accesso al vano cabina.</p> <p>Premere e mantenere premuto il tasto 3 per eseguire la chiusura della porta.</p> <p>Quando i pannelli incontrano l'ostacolo, si ha una completa inversione del movimento.</p> <p>Rilasciare il tasto 3 durante la riapertura</p>	<p>"CL" lampeggiante</p> <p>"IM" lampeggiante</p> <p>"OP" fisso o</p> <p>"- -" lampeggiante</p>
<p style="text-align: center; font-size: 2em; font-weight: bold;">6</p>	<p>Verifica del funzionamento in modalità Normale</p>	<p>Completare la chiusura della porta, se non effettuata: premere e tenere premuto il tasto 3 fino alla completa chiusura della porta.</p> <p>Rilasciare il tasto 3</p> <p>Attivare la modalità Normale di movimentazione, dalla modalità Ispezione, premendo il tasto 4 e verificare l'accensione del led NORMAL .</p> <p>Ora il controller lavora in modalità Normale, ed esegue i comandi ricevuti dal quadro di manovra, nonché le inversioni da barriere ottiche direttamente collegate al controller.</p> <p>Eeguire le verifiche di funzionamento con l'impianto in modalità Normale, dal tetto di cabina o dal piano, in base alle varie disposizioni per il personale di manutenzione.</p>	<p>"CL" lampeggiante</p> <p>"CL" fisso</p> <div style="display: flex; align-items: center;">  <div style="margin-left: 10px;"> <p>led NORMAL acceso</p> </div> </div>

Risoluzione problemi di installazione

La sequenza di installazione descrive tutti i passi che devono essere seguiti per una corretta e completa messa a punto del sistema.

Nel caso in cui si verificassero delle anomalie durante la fase di installazione, fare riferimento al manuale utente, parte relativa ai problemi e soluzioni

Per tutte le segnalazioni di allarme fare riferimento al manuale utente, paragrafo relativo agli allarmi.

Conformity Declaration (DDC)**Konformitätserklärung (DDC)****Dichiarazione di conformità (DDC)**

PR1166	CDD5.0: dichiarazione di conformità	Rev00
--------	-------------------------------------	-------

computec
www.computeonline.it

Computec s.r.l.
Via C.A. Dalla Chiesa, 5
25017 – Lonato del Garda (BS)

Computec s.r.l. dichiara, sotto la propria esclusiva responsabilità, che il prodotto:

CDD5.0 "Computec Door Drive 5.0"
per la movimentazione di porte per ascensore (modello CDD5.0, P1993)

è realizzato in conformità alle seguenti Direttive:

- MACCHINE 2006/42/CE
- LVD 2014/35/UE
- Rohs II 2011/65/CE
- EMC 2014/30/UE

ed è conforme alle seguenti norme armonizzate:

- EN 60335-1 (12/05/2010)
- EN 60335-2-89 (01/11/2011)
- EN 61000-6-2 (01/10/2006)
- EN 61000-6-3 (01/11/2007)
- EN 50581 (01/05/2013)
- EN 81-1 EN 81-2

ove applicabili.

Luogo: Lonato Del Garda
Data: 12/05/2017

(Firma leggibile del responsabile)

IT	Pagina 1/1
----	------------